

LOC		DIST		REVISIONS			
REV	DATE	BY	CHK	DESCRIPTION	DATE	OWN	APVD
A				RELEASED PER ECO-07-017382	01AUG2007	WS	AF

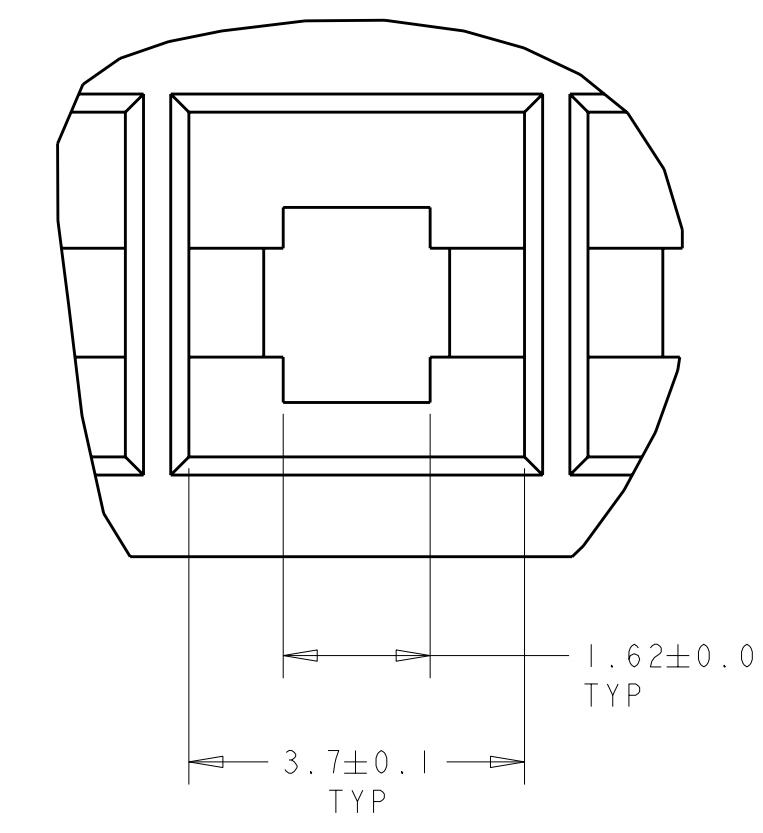

DETAIL A  
SCALE 12:1

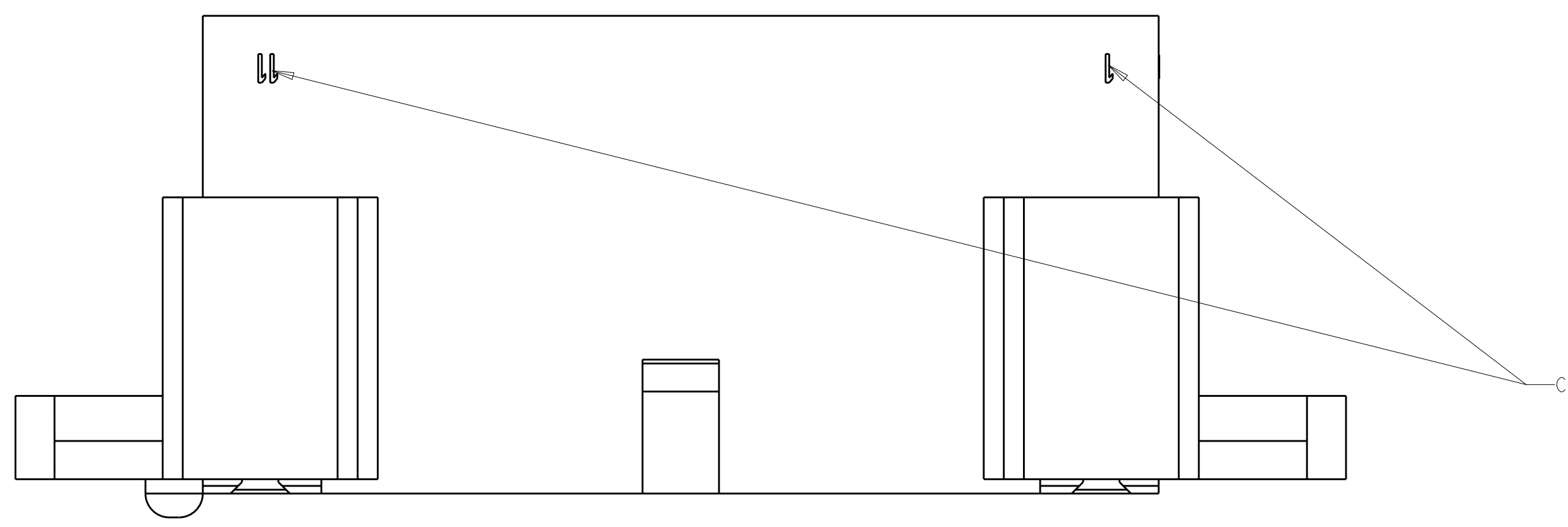
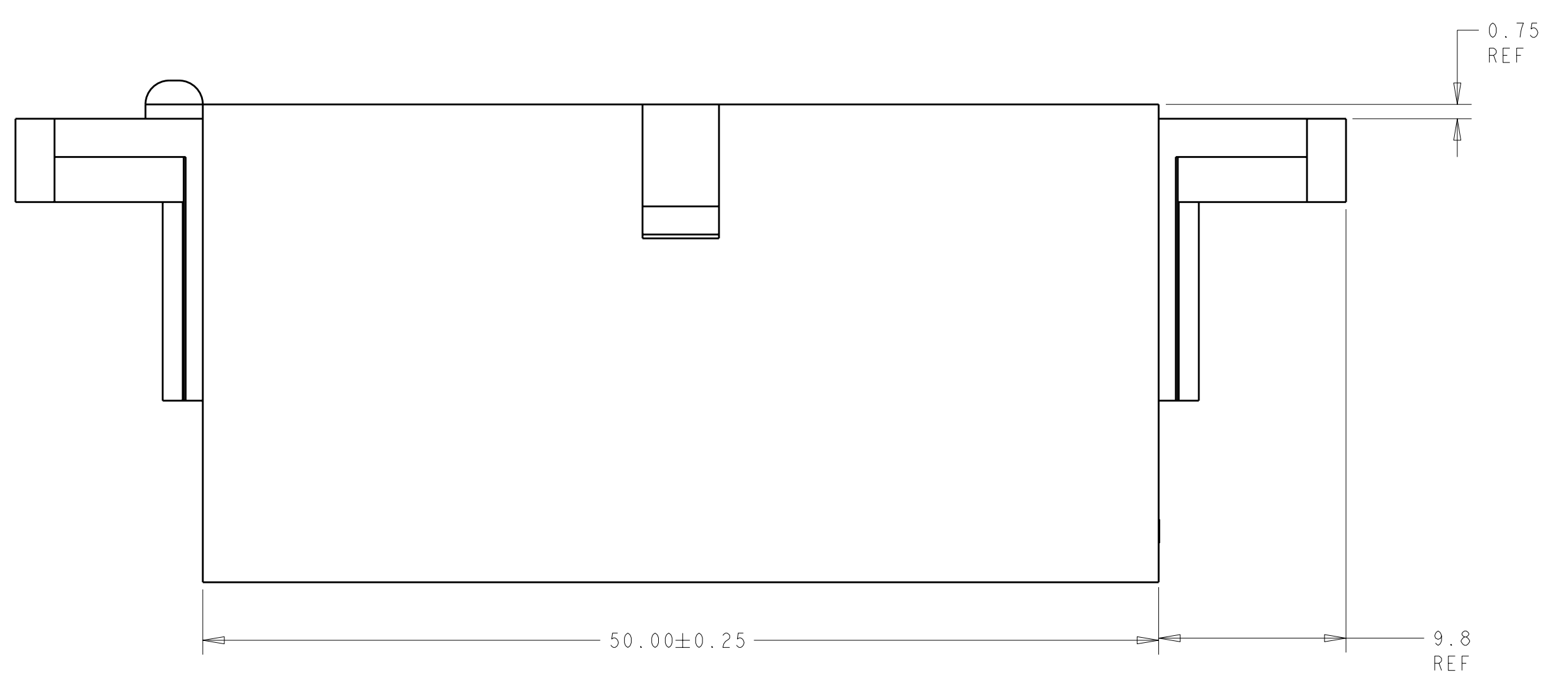
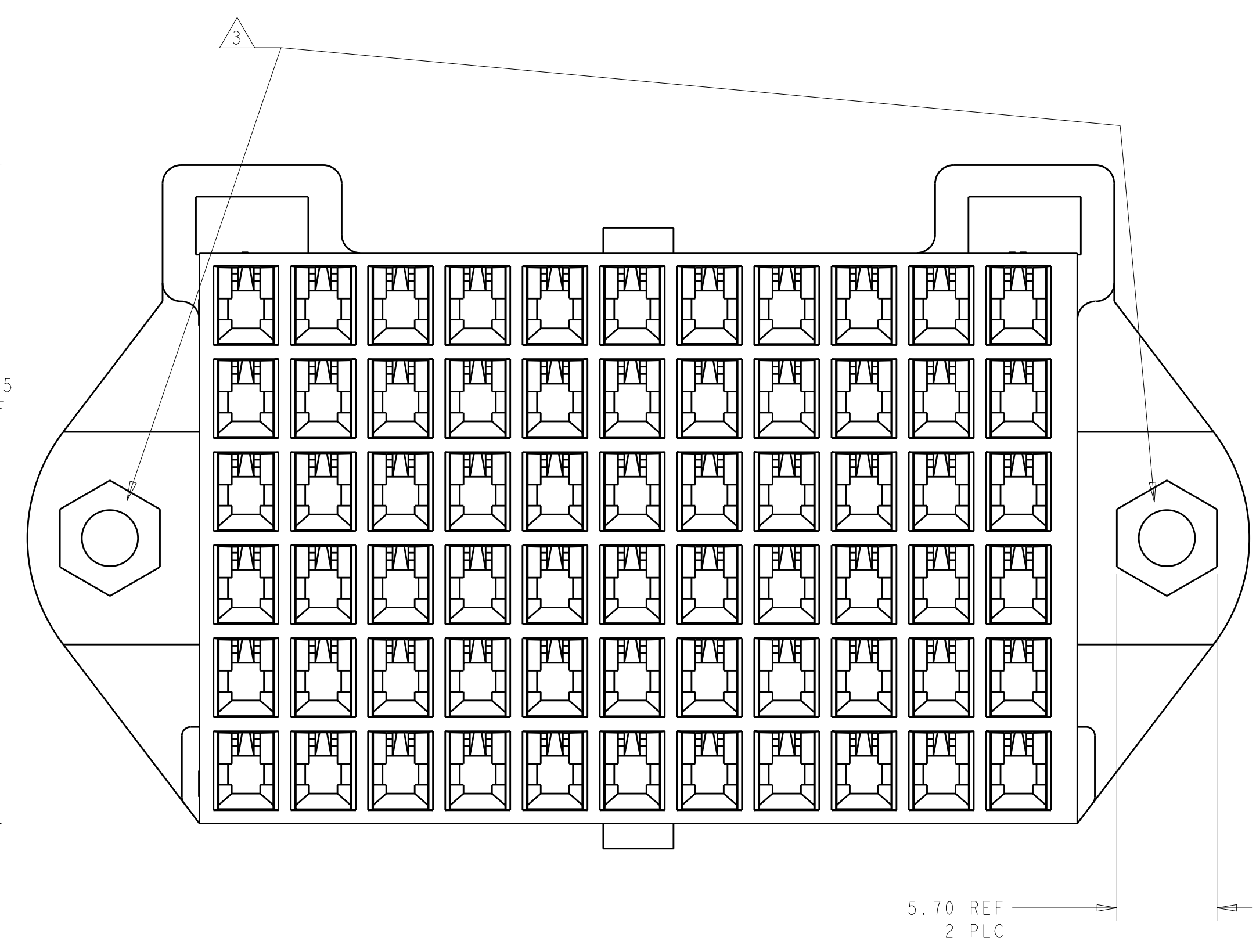
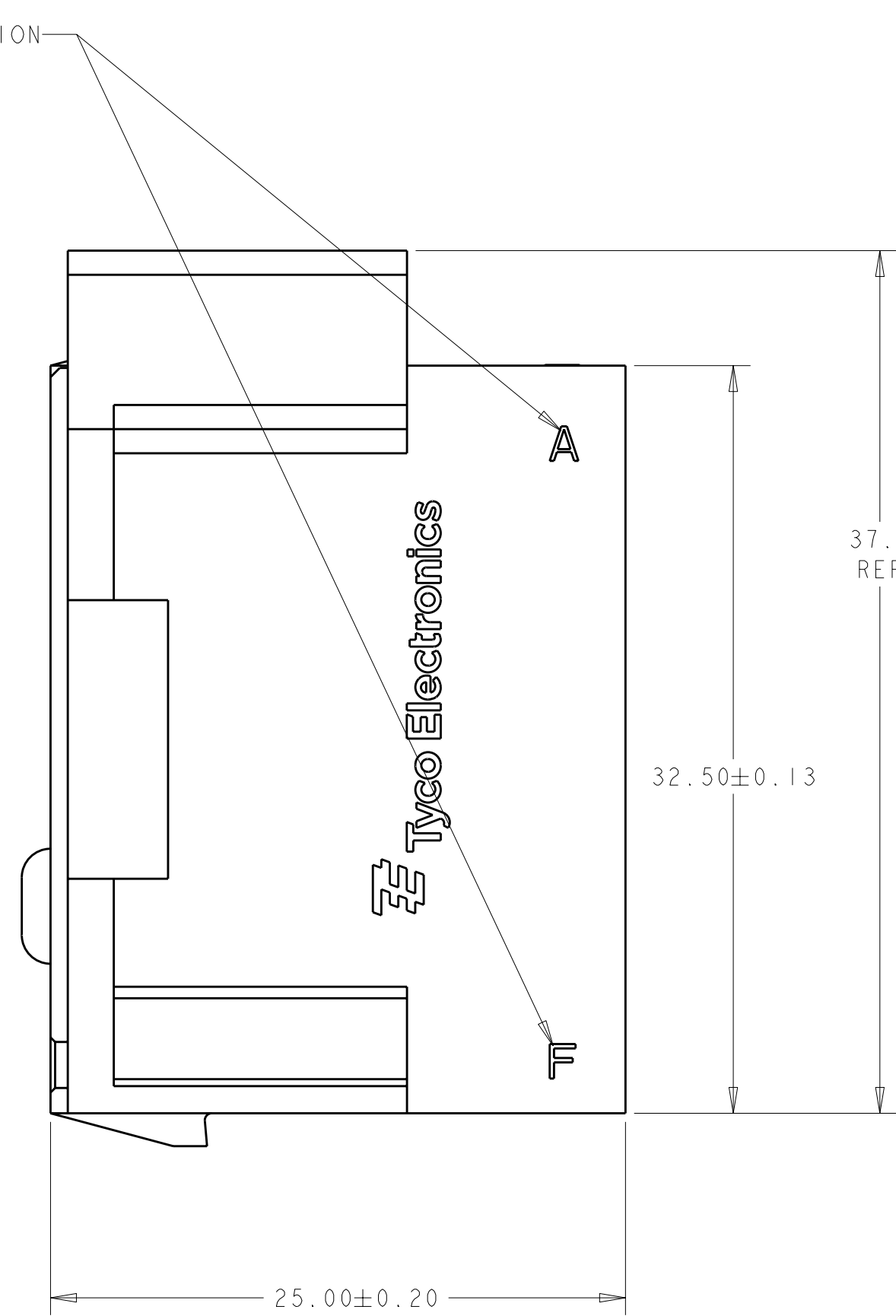
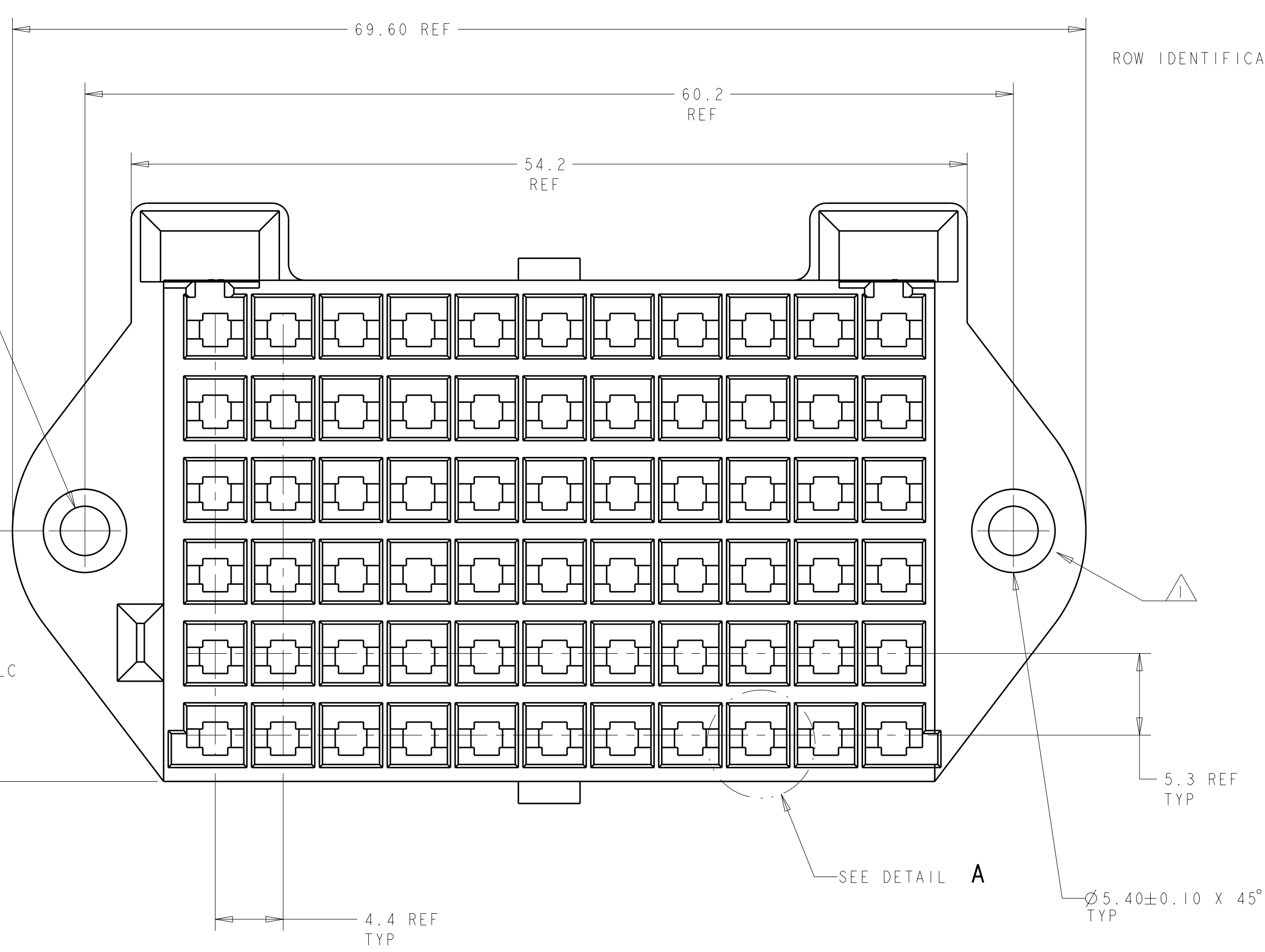

- 1. PBT UL94V-0.
- 2. ALL SHARP CORNERS ON PANEL CUT-OUT MAY HAVE A R0.1 MAX.
- 3. ALLOWS FOR A STYLE 1 M3 HEX NUT.

**CONFIDENTIAL**

1934143-1  
PART NUMBER

**THIS PRODUCT HAS NOT COMPLETED  
VALIDATION TESTING**

DIMENSIONS: mm 		TOLERANCES UNLESS OTHERWISE SPECIFIED: 9 PLC ± 1 PLC ± 2 PLC ± 3 PLC ± 4 PLC ± ANGLES ± FINISH ±		DWN: C. RITTER 01FEB2006 CHK: R. WHITEMAN 01FEB2006 APVD: - PRODUCT SPEC: 108-2248 APPLICATION SPEC: 114-13195 WEIGHT: - CUSTOMER DRAWING	Tyco Electronics Harrisburg, PA 17105-3608 66 POSITION PLUG HOUSING AMP-DUAC UPC SIZE: CAGE CODE: DRAWING NO: 114-13195 A100779C=1934143 SCALE: 1:1 SHEET 1 OF 2 REV A
-----------------------	--	---	--	---	--

LOC	DIST	REVISIONS			
AD	00	REV	DATE	BY	APPD
-	-	1	SEE SHEET 1	-	-
-	-	2			

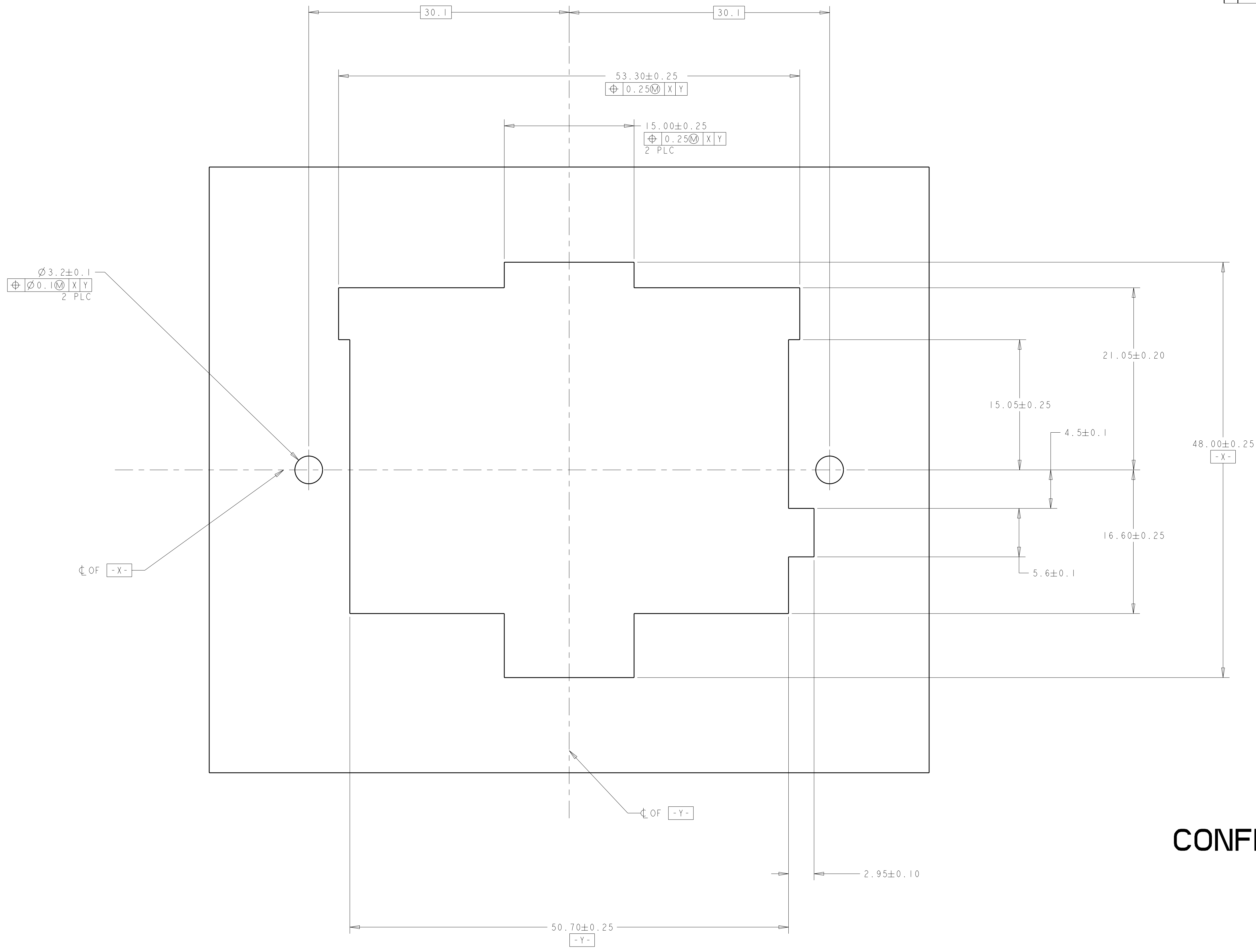

**CONFIDENTIAL**

**THIS PRODUCT HAS NOT COMPLETED  
 VALIDATION TESTING**

<small>THIS DRAWING IS UNPUBLISHED. RELEASED FOR PUBLICATION BY TYCO ELECTRONICS CORPORATION. ALL RIGHTS RESERVED.</small>		DWN: C. RITZER 01FEB2006 CHK: R. WHITEMAN 01FEB2006 APVD: -	<b>tyco</b> Electronics Tyco Electronics Harrisburg, PA 17105-3608
DIMENSIONS: mm 	TOLERANCES UNLESS OTHERWISE SPECIFIED: 0 PLC ± 1 PLC ± 2 PLC ± 3 PLC ± 4 PLC ± ANGLES ± FINISH ±	PRODUCT SPEC: 108-2248 APPLICATION SPEC: 114-13195 WEIGHT: - CUSTOMER DRAWING	NAME: 66 POSITION PLUG HOUSING AMP-DUAC UPC SIZE: A   00779   C=1934143 SCALE: 4:1 SHEET 2 OF 2 REV A